

Telescopic earthing bar TES1570

Earthing bar ES4547

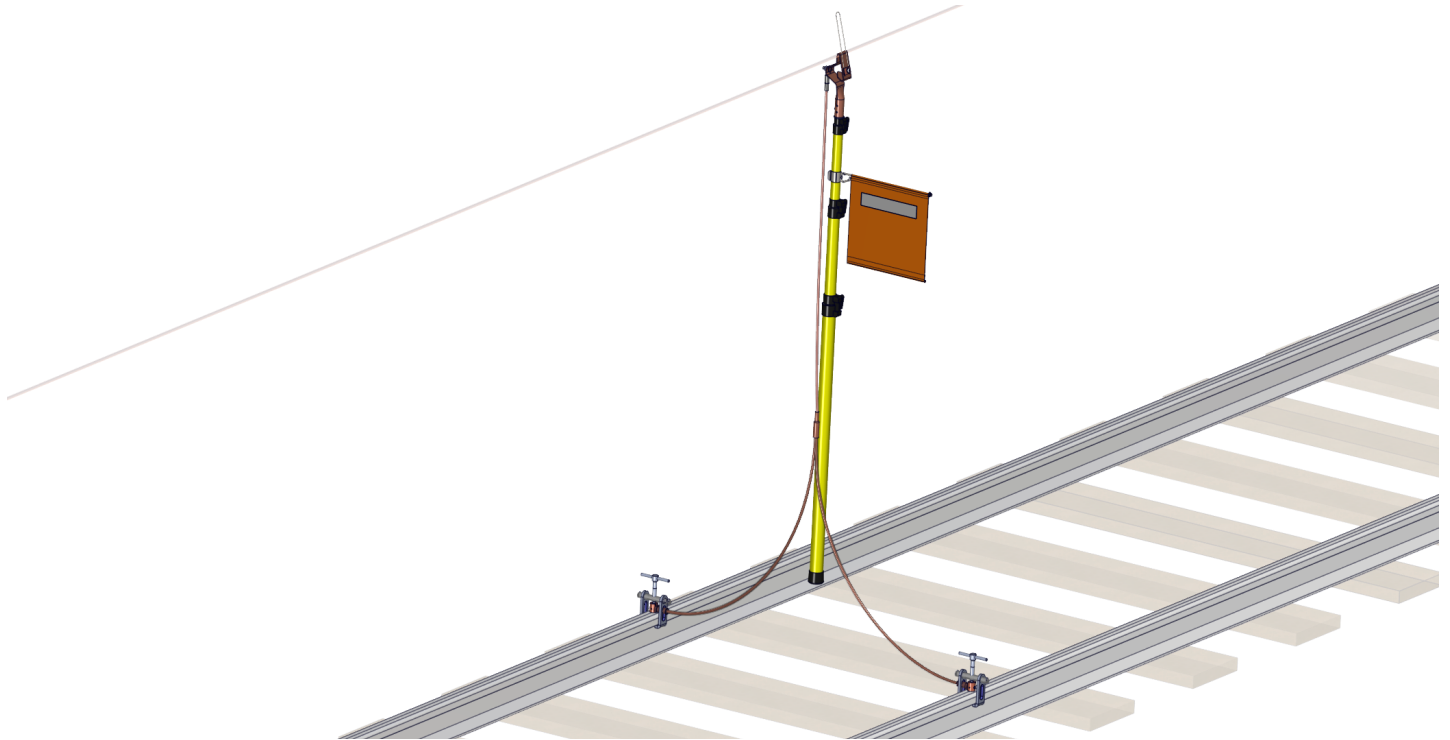

Index

1. Instructions on use of the operating manual.....	2
2. Safety instructions	4
3. Description.....	6
4. Operating modes	7
5. Commissioning	7
6. Normal operating mode	8
7. Service and maintenance	9
8. Storage.....	10
9. Disposal.....	10
10. Legal information	11



DANGER OF DEATH

Make sure before starting work on the overhead contact line that it has been switched off.

1. Instructions on use of the operating manual

Purpose

This operating manual contains important instructions and information for safe and problem-free operation and is a part of the earthing bar .



- The operating manual describes the earthing bar in the state in which it is first delivered after manufacture.
- For safe and problem-free operation and the fulfilment of any warranty claims, read the operating manual before every use and follow the instructions contained therein.
- The operating manual should be passed on to the subsequent owner or operator. The manufacturer / distributor is not liable for damage or malfunctions that result from the non-observation of this operating manual.
- Contact Arthur Flury AG if you have any questions after reading this operating manual.

Safekeeping

- As far as possible the operating manual must be kept in the immediate vicinity of the earthing bar and protected from emissions.
- This operating manual must be accessible to the operating personal at all times.
- The content must be continually and clearly legible throughout the lifetime of the product. Should any part of the operation and maintenance manual be missing or no longer legible, contact the manufacturer to replace the document.

Limitation of liability

The contents of this manual have been compiled under consideration of the applicable guidelines and standards, the state of the art and our many years of experience.







The manufacturer shall not be held liable for damage or accidents resulting from:

- Ignoring this manual
- Ignoring safety directives
- Incorrect use of equipment

Copyright protection

This operating manual must be treated as confidential. It is intended exclusively for the people who use the product. This manual may not be made accessible to third parties without written consent from Arthur Flury AG . The contents of the operating manual in the form of text, images, illustrations, drawings, diagrams or other depictions are protected by copyright of Arthur Flury AG.

Symbols used in the operating manual

Symbol	Meaning	Description
	General danger	General danger warning
	Danger from electrical voltage	Electrical voltage is dangerous to humans if a current is generated in the body through contact. Even small alternating voltages can trigger ventricular fibrillation. Direct voltage can cause burns.
	Instruction	A potentially harmful situation in which the product or an item in its environment could be damaged.
	Important	Instructions for use and other useful information.
	Wear eye protection	Protective eye wear must be worn.
	Wear foot protection	Protective foot wear must be worn.
	Wear hand protection	Protective hand wear must be worn.

2. Safety instructions

Target group

This operating manual is intended for technical specialist personnel and operators. Where specific target groups are addressed, these are noted in the individual chapters. Only those persons are approved to carry out the corresponding activities. The remaining contents of the operating manual apply for all target groups.

Technical specialist personnel

- | | |
|--------------------------------|--|
| Qualification | <ul style="list-style-type: none">• Mechanical and electrical basic training• Electrician• Product-specific training |
| Autorisation / activity | <ul style="list-style-type: none">• Commissioning• Operation• Service and maintenance• Instruction of operating personnel |

Operator

- | | |
|--------------------------------|---|
| Qualification | <ul style="list-style-type: none">• Product-specific training• Electrical engineer |
| Autorisation / activity | <ul style="list-style-type: none">• Operation• Service and maintenance |

General safety instructions

This product may only be used when it is in a technically intact and operationally safe state. It must be inspected for integrity before commissioning. For safety reasons, earthing and short circuit equipment must be handled with great care.

Residual dangers

This product is produced according to the latest state of the art and the generally-acknowledged safety regulations. Nevertheless, its use may present dangers for life and limb of the user or third parties or detrimental effects to this product and other property.

There are dangers associated with the use of technical products. Dangers which cannot be prevented by design measures or protective measures are residual dangers. The safety instructions in this operating manual refer to the known residual dangers. If additional dangers show up in operation, the operator is obliged to disclose these immediately to Arthur Flury AG.

The following residual dangers may occur:

- If a product has triggered a short circuit, it may not be used again before a full service has been carried out.
- In the event of a short-circuit, the earthing cables will blow out and may endanger bystanders.
- Stumbling and falling dangers due to materials lying on the floor.

Obligation of the operator

The operator shall only allow persons to work with the product who

- are familiar with the basic directives on occupational safety and accident prevention
- are trained electricians or persons who have been instructed in electrical engineering
- have undergone training to work with this product
- have read and understood this operating manual

Correct use of equipment

This earthing bar is designed for the temporary earthing and short circuiting of electrically isolated overhead lines.

It prevents the unwanted re-activation of overhead line during servicing and repair work on the rail network. It is intended only for use on overhead lines. Make sure, before use, that the workplace is fully isolated from voltage.

Any other use is considered as incorrect, and renders void all liability and warranty claims against Arthur Flury AG.

Interventions and changes which affect the safety equipment and functionality may only be undertaken by Arthur Flury AG.

Problem-free and safe operation assumes qualified operation and correct maintenance.

All relevant accident prevention directives and the other generally acknowledged technical and occupational safety rules must be observed.

Designed for defined short circuit currents

An earthing kit with associated components (contact wire hook, rail clamp, earthing cable) is designed for defined short circuit currents. The maximum short circuit currents that are permitted in the overhead line system must be known when configuring the earthing kit.

An earthing kit may only be used in the overhead line system for which it is intended. There is otherwise the danger that the earthing kit will not fulfil its function.

Incorrect use of equipment

Any use other than the use defined under "Correct use of equipment" or which exceeds this use is classed as incorrect use of equipment.

Incorrect use of equipment renders void all liability and warranty claims against Arthur Flury AG.

3. Description

Earthing kit with associated components / scope of delivery
 (Exemple view of an earthing kit)

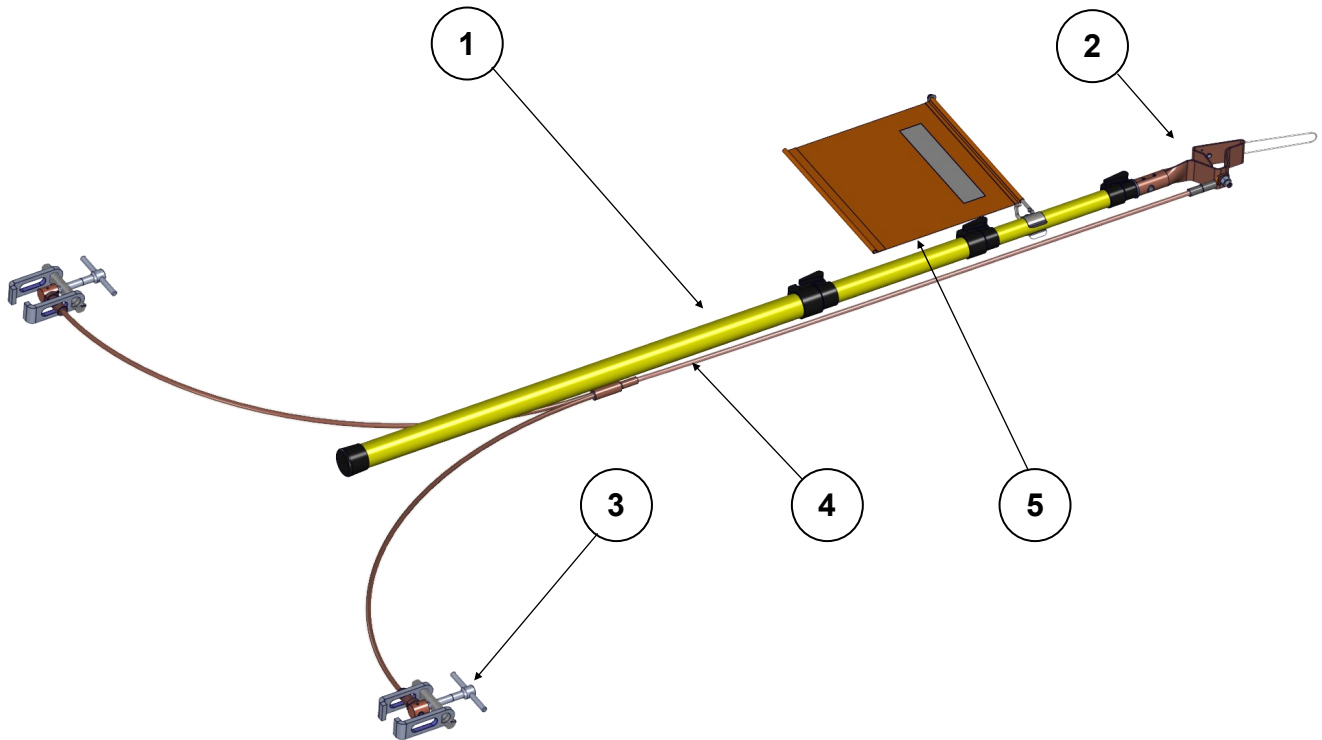

1 Earthing bar

Telescopic earthing bar
 4-part, steplessly extending

Earthing bar
 2-part, defined length

2 Contact wire hook

Contact hook
 For earthing overhead contact line

Contact hook
 For earthing overhead contact line with probe tip

3 Rail clamp

Parallel rail clamp
 Fits all rail heads. Earthing cable connection 50 mm²

Diagonal rail clamp
 Fits different rail profiles. Earthing cable connection 50 mm² or 95 mm²

Groove rail clamp
 Fits groove rails, earthing cable connection 50 mm²

Profile-free rail clamp
 Fits all rail profiles

KAGO contact clamp
 For temporary or permanent rail earthing

Magnetic earthing contact
 Universal magnetic earthing contact

4 Earthing cable

Single-pole earthing cable

For attachment to a rail

Bipolar earthing cable

For attachment to both rails

5 Signal flag

Signal flag including fixtures (optional)

4. Operating modes

The earthing bar can be used in the following operating modes:

Operating mode	Description
Commissioning	Connecting components (earthing bar, contact wire hook, rail clamp and earthing cable) to an earthing kit.
Normal operating mode	Earthing live overhead lines in AC & DC systems. according to the generally acknowledged principles of earthing overhead lines.
Service and maintenance	Service and maintenance of the safety and function of the product according to the service and maintenance schedule.

5. Commissioning

Personnel qualification

	Mandatory presence:	Technical specialist personnel
	Optional presence:	Operator

Connection of earthing cable to contact wire hook

Attach the earthing cable to the contact wire hook with the M12 cable lug. Ensure that the fixing screw turns smoothly. Tightening torque: **25 Nm**

Connect the earthing cable to the rail clamp

Attach the earthing cable to the rail clamp with the M12 cable lug. Ensure that the fixing screw turns smoothly. Tightening torque: **25 Nm**

Attach contact wire hook to the earthing bar

Insert the contact wire hook into the designated aperture in the earthing bar. Ensure that the catch is engaged and the contact wire hook is firmly connected to the earthing bar.

6. Mode de service normal

Personnel qualification

	Mandatory presence:	Technical specialist personnel
	Optional presence:	Operator



During operation, wear suitable protective gear to prevent injury from residual dangers.

Preparation:

Ensure that

- the earthed rail profile, to which the earthing bar is attached, is clean, bare, and largely free from grease
- the earthing bar is intact and undamaged

The overhead line must be isolated from voltage before assembly of the earthing bar. Subject to the local directives and regulations of the operator.

- Disconnecting the overhead line
- Secure the overhead line against reactivation
- Ensure isolation from voltage
- Earth and short circuit the overhead line
- Cover or restrict adjacent live lines

Connect the rail clamp to the rail

Connect the rail clamp to the rail and tighten. Check the attachment of the rail clamp. The contact surfaces of the rail clamp must be fully in contact with the rail.

Connect the contact wire hook

Attach the earthing bar to the contact wire with the contact wire hook.

After use:

Detach the contact wire hook

Remove the earthing bar from the contact line.

Detach the rail clamp

Remove the rail clamp from the rail.

7. Service and maintenance

Personnel qualification

	Mandatory presence:	Technical specialist personnel
	Optional presence:	Operator

Maintenance

For safety reasons, handle the earthing bar with great care. Check it thoroughly before use. The same applies to the accessories. Any damage to the cable sheath, any signs of bare cable wire or any damage to contact surfaces must be seen as serious damage, which excludes reuse. There is danger of death if the earthing bar is not kept fully serviced.

Correct and careful handling contributes to the longevity of the product. The service or replacement of defective parts increases the operating functions. Check that the earthing bar, including accessories, is fully functioning before every use. If defects or issues are found, you must carry out a full service before using the equipment again.

We recommend servicing the individual components regularly and replacing them in the event of damage or doubt. Safe use cannot otherwise be guaranteed. Arthur Flury AG supplies spare parts for all components. The earthing bar can also be sent away for servicing.

Earthing bar

Heavy contamination or caked-on deposits must be cleaned off. Check the pipes for damage. Cracks, fractures and deformation lead to water ingress and reduce safety. Also, the damaged surfaces can lead to hand injuries. Defective pipes must be replaced. Check if locks and end caps are fully functioning and intact. Replace if defects are found.

Contact wire contact hook

Check the hook for wear or scorching. Beads of weld indicate a short circuit or other current influences, which require special attention. Bent hooks or hooks with a reduced cross section must be replaced. Check the cable lug and the cable crimps for bending and reduced cross section. If in any doubt, they must be replaced because the cable may otherwise come off the hook when assembled. Check the sensor tip (if present) for wear and replace it if worn.

Earthing cable

Check the highly flexible cable for damage and breaks. Electrical influences can cause the material to become brittle and stiff, which can cause the cable to break. Inspect the cable sheath and all shrink hoses for tightness. If in doubt, replace the earthing cable. The guide value for the tightening torque between the earthing cable and earthing hook or rail clamp is **25 Nm**.

Rail clamps

Check the cable lug and the cable crimps for bending and reduced cross section. They must be replaced if in any doubt. Check all individual items for electrical influences. Carry out a function check and grease the moving parts.



Some of the tasks above depend greatly on ambient conditions. The cycles specified above are minimum requirements. Maintenance cycles may be different in individual cases.

8. Storage

Store the earthing bar in the corresponding bag.

Relative humidity: 20 - 96% (non-condensing)

Air temperature: -30°C ... +50°C

No long-term direct sunlight

The earthing kit should be kept in the protective bag and secured against third party access.

9. Disposal



All earthing bar components must be separated according to the type of material and disposed of correctly according to local guidelines and specifications.

If necessary, the manufacturer and / or retailer will be happy to give further help.

10. Legal information

The product must only be operated by trained specialists.

The product can be permanently damaged by loads that exceed the maximum values. If the product is exposed to absolute maximum loading for an extended period, it may impair the product's reliability and life. Arthur Flury AG will not accept any liability in this case.

Arthur Flury AG will not accept any liability for incorrect use and use for applications other than those specified in these instructions.

If damage to the product is suspected, any use or operation must be stopped immediately. Arthur Flury AG will not accept any liability in the event of continued use despite suspected damage.

Due to the diverse ways in which this product can be used, the instructions for use represent a general guide only and do not constitute a guarantee of the product's suitability for use in a specific application. The user is responsible for checking the full product data and clarifying the product's suitability for the intended use. The user is responsible for the choice of product and compliance with all the safety regulations and warnings. Please contact Arthur Flury AG if you require additional product information.

Our products comply with the current legal requirements and regulations (including RoHS, REACH, WEEE) in the markets where we operate. Please refer to Arthur Flury AG's Code of Conduct, available on our website, for further information.

These instructions are intended to provide the customer with information and should not be supplied unless accompanied by the product. The products and information in this publication require appropriately trained specialist personnel. Despite the greatest care being taken, the instructions may contain inaccuracies or typographical errors for Arthur Flury AG will not accept any liability. Arthur Flury AG may amend the instructions at any time, without notice, in the interests of technical progress. The customer is responsible for downloading an up-to-date version of the instructions from Arthur Flury AG's website before using the product.

Any brand and product names used in these instructions are registered marks ® or trademarks™ of their respective owners.

Arthur Flury AG will not accept any liability for damage incurred as a result of failure to comply with these instructions.



Arthur Flury AG