

---

Absturzsicherung:  
EN795 – Seilsystem Flury Line

---

Protection antichute :  
EN795 – Système lignes de vie  
Flury Line

---

Protezione anticaduta:  
EN795 – Sistema linea vita Flury Line

---

Fall protection:  
EN795 – Lifeline system Flury Line

---

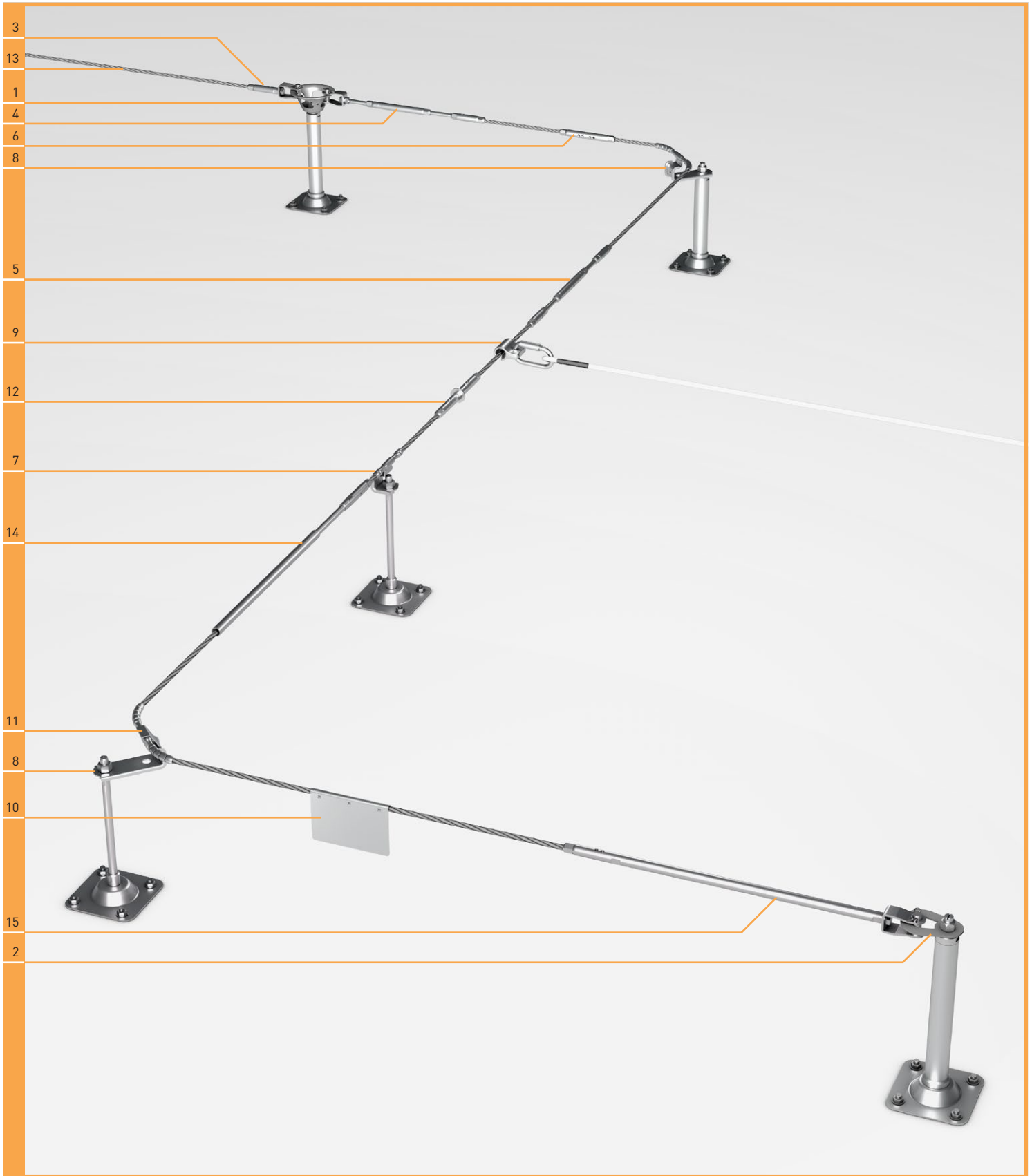



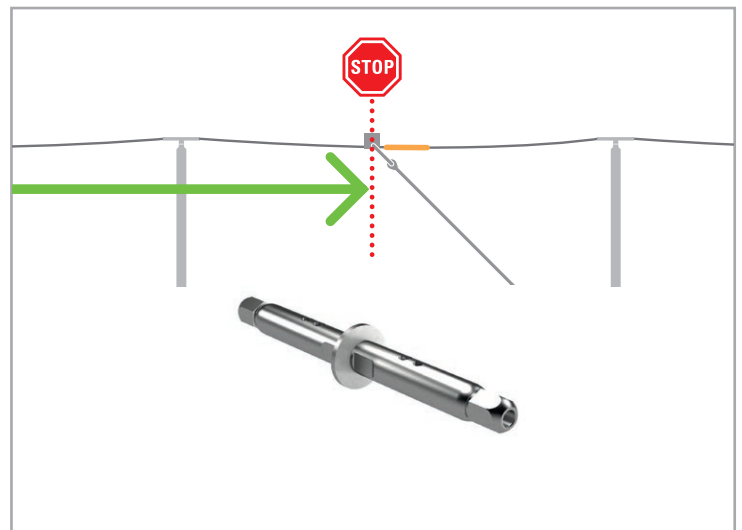
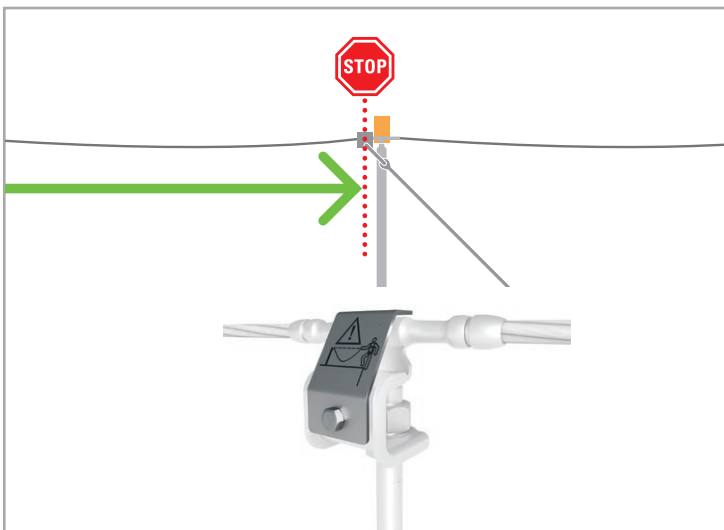
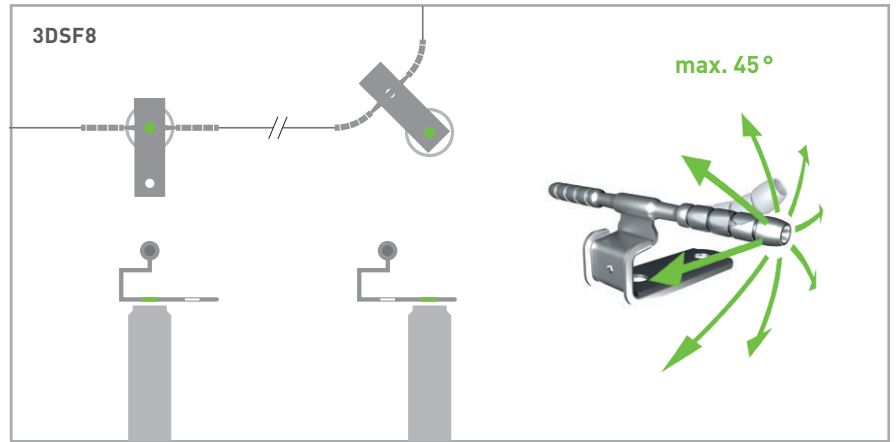
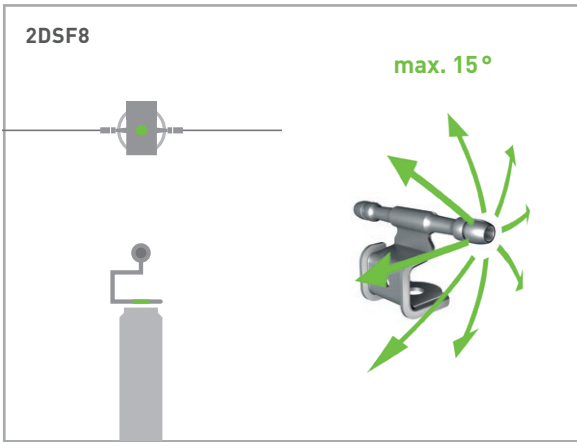
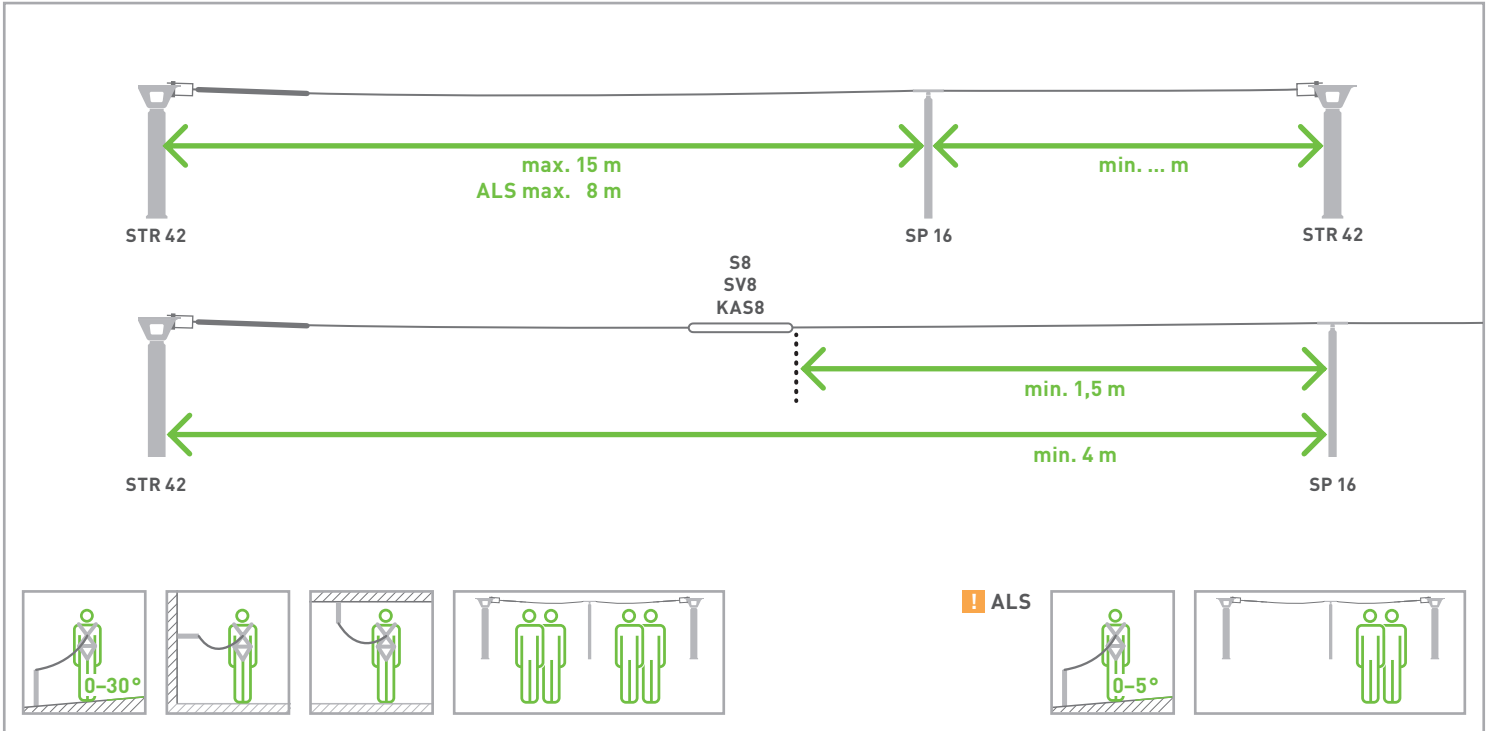

	AF-Typ	AF Art. N°
1	EAP Q	310.000.007
2	EAP F	310.000.006
3	GK8	320.000.003
4	GKS8	320.000.004
5	S8	320.000.005
6	SV8	320.000.012
7	2DSF8	320.000.013
8	3DSF8	320.000.007

	AF-Typ	AF Art. N°
9	GL8	320.000.019
10	SYSKS d/f	320.000.027
11	Lock	380.000.179
12	Lock	320.000.032
13	InoxD8	320.000.001
14	KAS8	320.000.017
15	KAG8	320.000.018



Minimale Stützenabstände  
Espacement minimal entre les tiges

Spaziatura minima tra le colonne  
Minimal spacing between columns

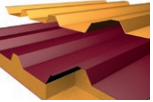
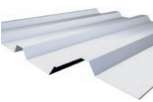
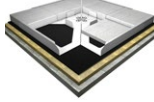
h mm							
0	0.4 m	0.4 m	0.6 m	0.4 m	0.4 m	2.0 m	2.0 m
100	0.4 m	0.4 m	0.6 m	0.4 m	0.4 m		2.0 m
200	0.6 m	0.6 m	0.6 m	0.6 m	0.6 m		2.0 m
300	0.8 m	0.8 m	1.2 m	0.8 m	0.8 m		2.0 m
400	1.0 m	1.0 m	1.2 m	1.0 m	1.0 m		
500	1.2 m	1.2 m	1.2 m	1.2 m	1.2 m		
600	1.4 m	1.4 m	1.8 m	1.4 m	1.4 m		
700	1.6 m	1.6 m	1.8 m	1.6 m			
800	1.8 m	1.8 m	1.8 m	1.8 m			
900	2.0 m	2.0 m	2.4 m	2.0 m			

**Typ A**  
F max. = 15 kN

**Typ C**  
EN795:2012 Typ C / DIN CEN/TS 16415:2013

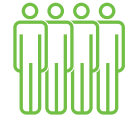

**X** KAG8 / KAS8

F max. = 25 kN

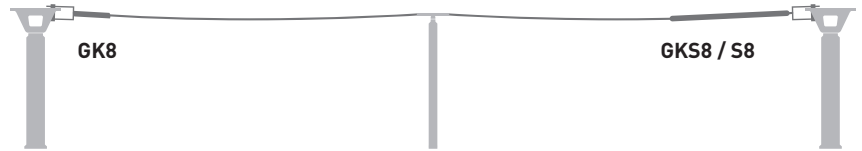
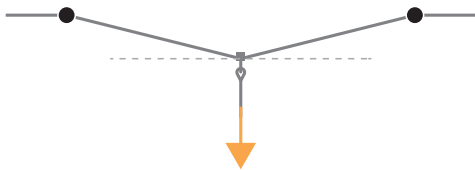

h mm	2 m	5 m	10 m	15 m
0	0.3 m	0.6 m	1.0 m	1.4 m
100	0.5 m	0.8 m	1.3 m	1.8 m
200	0.7 m	1.0 m	1.6 m	2.2 m
300	0.8 m	1.2 m	1.9 m	2.5 m
400	1.0 m	1.4 m	2.1 m	2.8 m
500	1.2 m	1.6 m	2.4 m	3.2 m
600	1.3 m	1.8 m	2.7 m	3.5 m
700	1.5 m	2.0 m	2.9 m	3.8 m
800	1.7 m	2.2 m	3.2 m	4.1 m
900	1.8 m	2.4 m	3.5 m	4.5 m

**✓** KAG8 / KAS8

F max. 25 kN ⇒ 10 kN

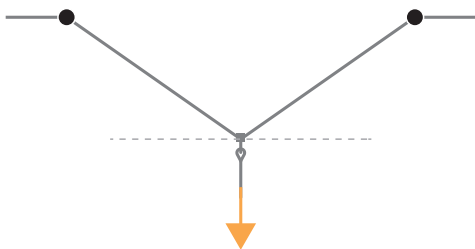

h mm	2 m	5 m	10 m	15 m
0	0.9 m	1.3 m	1.9 m	2.5 m
100	1.0 m	1.4 m	2.1 m	2.8 m
200	1.1 m	1.6 m	2.3 m	3.1 m
300	1.3 m	1.7 m	2.5 m	3.3 m
400	1.4 m	1.9 m	2.8 m	3.6 m
500	1.5 m	2.1 m	3.0 m	3.9 m
600	1.7 m	2.2 m	3.2 m	4.2 m
700	1.8 m	2.4 m	3.4 m	4.4 m
800	1.9 m	2.6 m	3.7 m	4.7 m
900	2.1 m	2.8 m	3.9 m	5.0 m

Temp.:

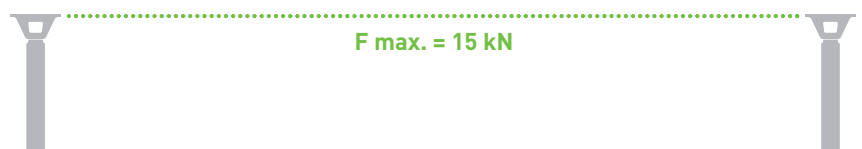

Absturzicherungssystem /  
 Système de protection antichute /  
 Sistema di protezione anticaduta /  
 Fall protection system

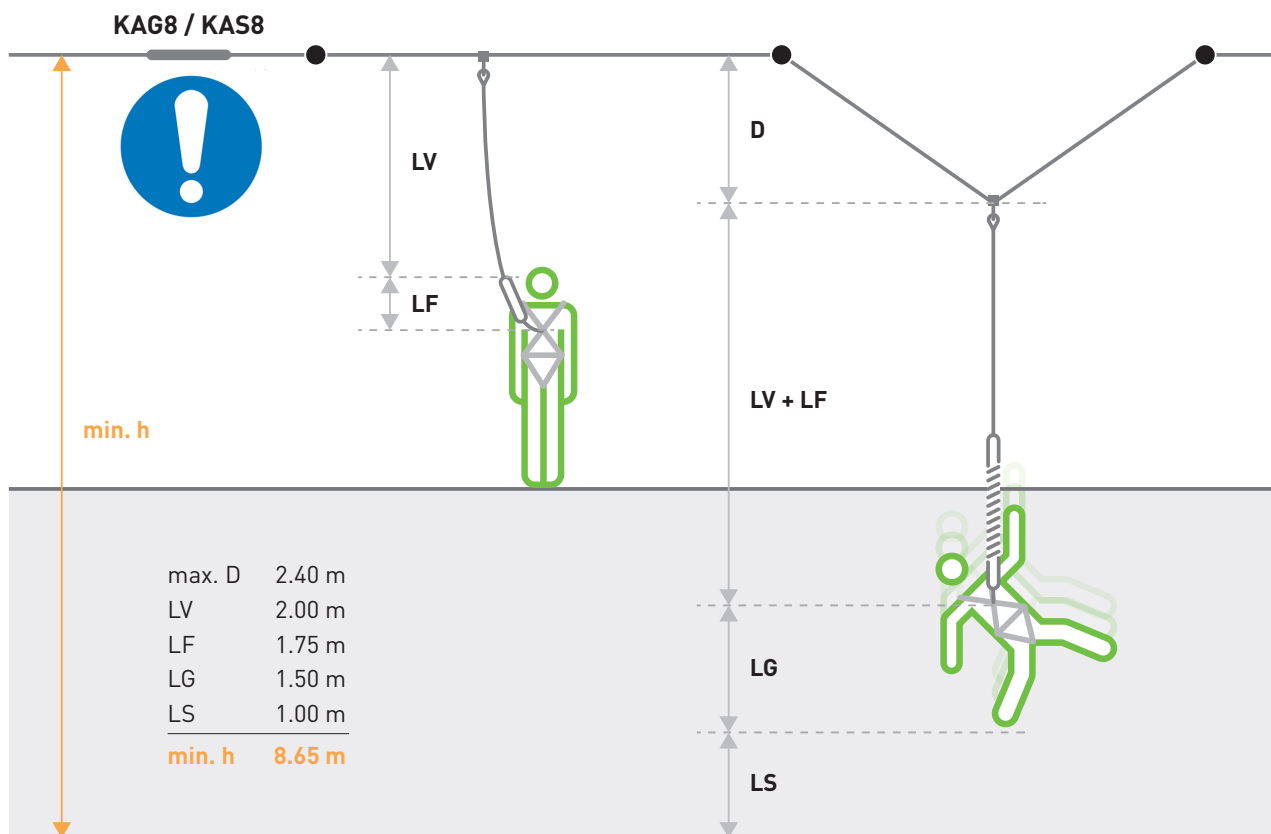

Rückhaltesystem /  
 Système de retenue /  
 Sistema di ritenuta /  
 Restraint system

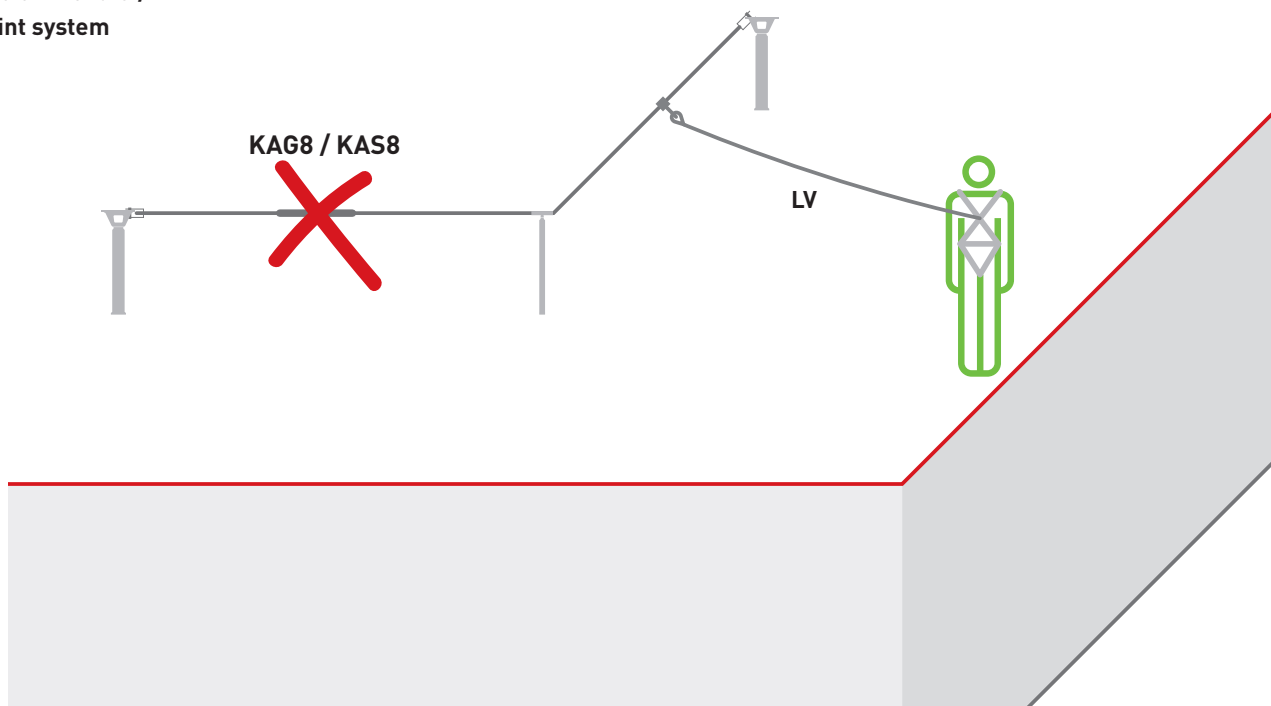

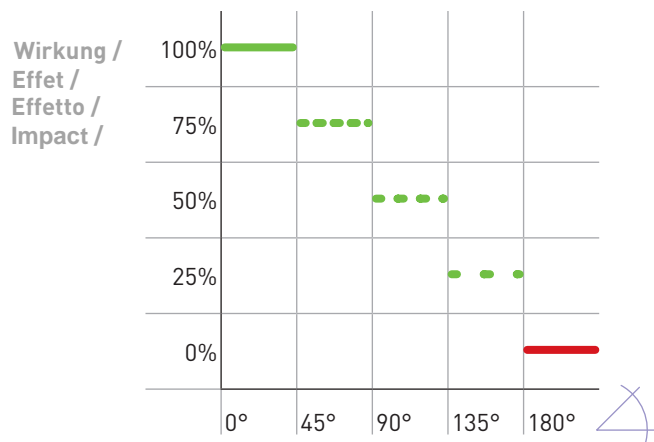
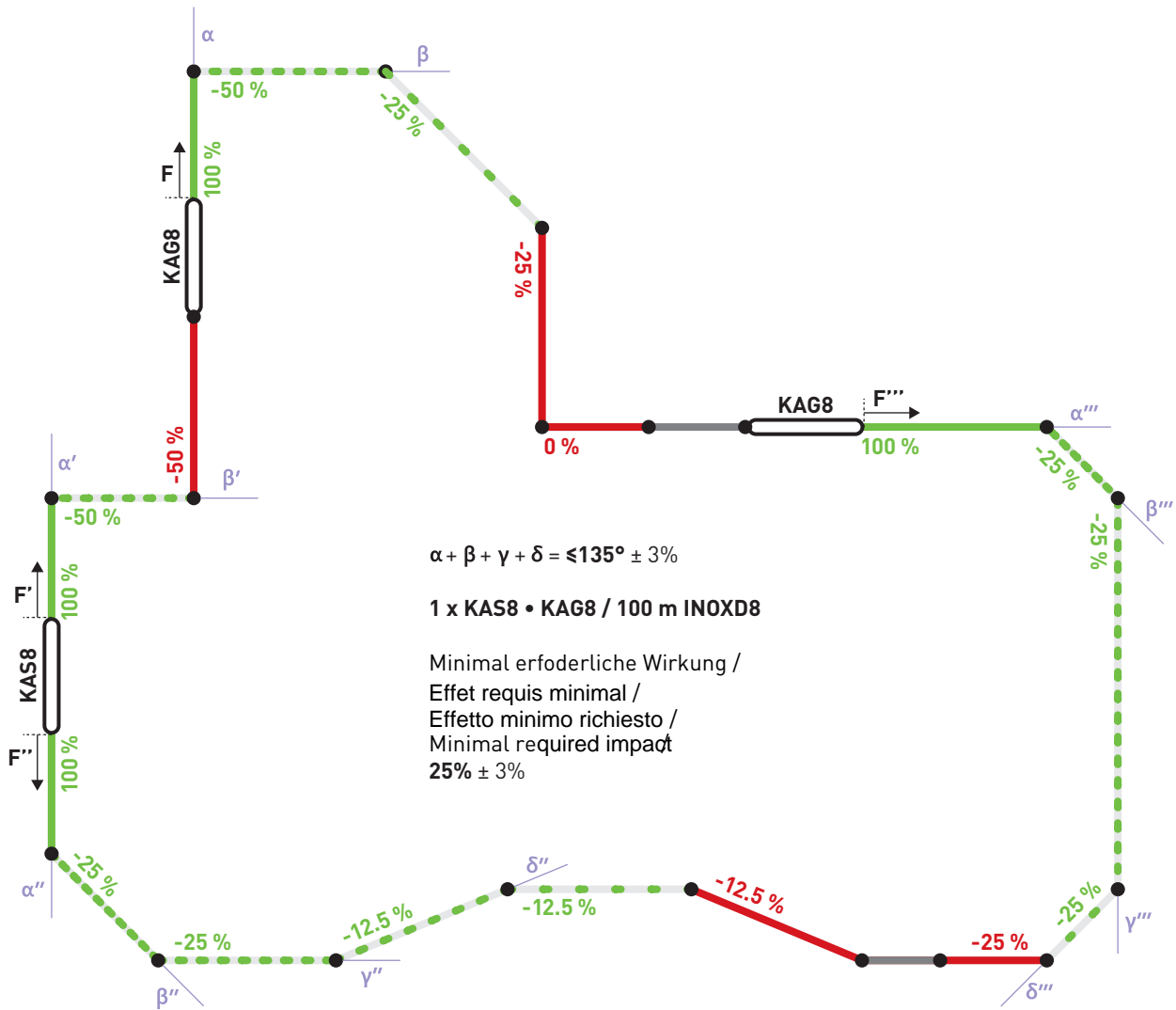

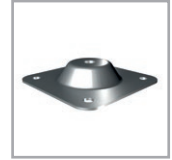
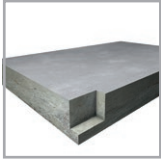

SP 16 B KL  
SP 20 B KL

P U2

P U4

P B

P B	✓			✓		900	✓	✓	✓
P U2	✓	✓	✓		✓	max. 600	✓	✓	✓
P U4	✓	✓	✓		✓	900	✓	✓	✓
SP 16 H P	✓	✓	✓		✓	500	max. 300	max. 300	✓
STR 42	✓	✓	✓		✓	900	✓	✓	✓
SP 16 B KL	✓	✓	✓		✓	500	max. 300	max. 300	✓
SP 20 B KL	✓	✓	✓		✓	500-900			✓
Quattro	✓	✓	✓		✓		✓	✓	✓
EAP F	✓	✓	✓		✓		✓		
2DSF8	✓	✓	✓		✓				✓
3DSF8	✓	✓	✓		✓			✓	✓

Absturzicherungssystem / Système de protection antichute / Sistema di protezione anticaduta / Fall protection system

KAS8 / KAG8 + P						0			
KAS8 / KAG8 + P + STR / SP						100-900			

Rückhaltesystem / Système de retenue / Sistema di ritenuta / Restraint system

KAS8 / KAG8 + P						0			
KAS8 / KAG8 + P + STR / SP						100-900			





SP 16 H  
SP 20 H

P U2

P U4

P B

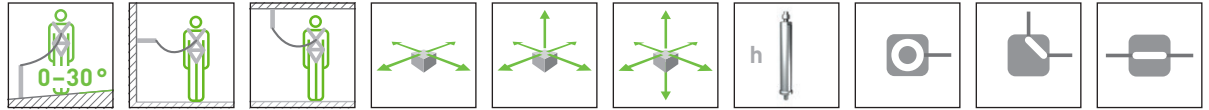

P B	✓			✓			900	✓	✓	✓
P U2	✓	✓	✓		✓		max. 600	✓	✓	✓
P U4	✓	✓	✓		✓		900	✓	✓	✓
SP 16 H P	✓	✓	✓		✓		500	max. 300	max. 300	✓
STR 42	✓	✓	✓		✓		900	✓	✓	✓
SP 16 H	✓	✓	✓		✓		500	max. 300	max. 300	✓
SP 20 H	✓	✓	✓		✓		500-900			✓
Quattro	✓	✓	✓			✓		✓	✓	✓
EAP F	✓	✓	✓		✓			✓		
2DSF8	✓	✓	✓			✓				✓
3DSF8	✓	✓	✓			✓			✓	✓

Absturzicherungssystem / Système de protection antichute / Sistema di protezione anticaduta / Fall protection system

KAS8 / KAG8 + P	!	!	!				0			
KAS8 / KAG8+ P + STR / SP							100-900			

Rückhaltesystem / Système de retenue / Sistema di ritenuta / Restraint system

KAS8 / KAG8 + P							0			
KAS8 / KAG8 + P + STR / SP							100-900			

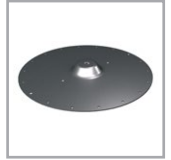

PH

<b>PH</b>	✓	✓	900	✓	✓	✓
<b>SP 16 H P</b>			500	max. 300	max. 300	✓
<b>STR 42</b>			900	✓	✓	✓
<b>Quattro</b>				✓	✓	✓
<b>EAP F</b>				✓		
<b>2DSF8</b>						✓
<b>3DSF8</b>					✓	✓

**Absturzicherungssystem / Système de protection antichute / Sistema di protezione anticaduta / Fall protection system**

<b>KAS8 / KAG8 + P</b>			0			
<b>KAS8 / KAG8 + P + STR / SP</b>			100-900			

**Rückhaltesystem / Système de retenue / Sistema di ritenuta / Restraint system**

<b>KAS8 / KAG8 + P</b>			0			
<b>KAS8 / KAG8 + P + STR / SP</b>			100-900			

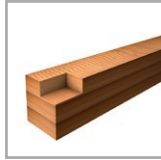

P U2



P U4



P R9

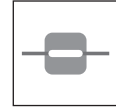
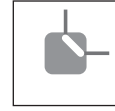
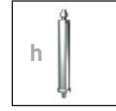
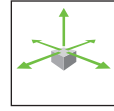
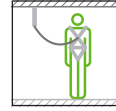
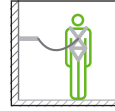
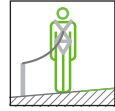

P R9	✓	✓	✓	✓	max. 600	✓	✓	✓
P U2	✓	✓	✓	✓	max. 600	✓	✓	✓
P U4	✓	✓	✓	✓	900	✓	✓	✓
SP 16 H P					500	max. 300	max. 300	✓
STR 42					900	✓	✓	✓
Quattro						✓	✓	✓
EAP F						✓		
2DSF8								✓
3DSF8							✓	✓

Absturzicherungssystem / Système de protection antichute / Sistema di protezione anticaduta / Fall protection system

KAS8 / KAG8 + P	⚠	⚠	⚠		0			
KAS8 / KAG8 + P + STR / SP	⚠	⚠	⚠		100–900			

Rückhaltesystem / Système de retenue / Sistema di ritenuta / Restraint system

KAS8 / KAG8 + P					0			
KAS8 / KAG8 + P + STR / SP					100–900			



Set S



PT

P T	✓	✓	max. 600	✓	✓	✓
Set S				✓	✓	
SP 16 H P			500	max. 300	max. 300	✓
STR 42			max. 600	✓	✓	✓
Quattro				✓	✓	✓
EAP F				✓		
2DSF8						✓
3DSF8					✓	✓

**Absturzversicherungssystem / Système de protection antichute / Sistema di protezione anticaduta / Fall protection system**

KAS8 / KAG8 + P			0			
KAS8 / KAG8 + P + STR / SP			100-900			

**Rückhaltesystem / Système de retenue / Sistema di ritenuta / Restraint system**

KAS8 / KAG8 + P			0			
KAS8 / KAG8 + P + STR / SP			100-900			

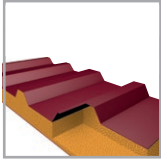

Set S



PT

P T	✓	✓	max. 600	✓	✓	✓
Set S				✓	✓	
SP 16 H P			500	max. 300	max. 300	✓
STR 42			max. 600	✓	✓	✓
Quattro				✓	✓	✓
EAP F				✓		
2DSF8						✓
3DSF8					✓	✓

Absturzsicherungssystem / Système de protection antichute / Sistema di protezione anticaduta / Fall protection system

KAS8 / KAG8 + P			0			
KAS8 / KAG8 + P + STR / SP			100-900			

Rückhaltesystem / Système de retenue / Sistema di ritenuta / Restraint system

KAS8 / KAG8 + P			0			
KAS8 / KAG8 + P + STR / SP			100-900			

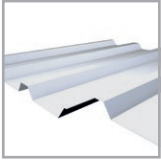

Set S



PT

P T	✓	✓	✓	✓	✓
Set S			✓	✓	✓
Quattro			✓	✓	✓
EAP F			✓		
2DSF8					✓
3DSF8				✓	✓

Absturzicherungssystem / Système de protection antichute / Sistema di protezione anticaduta / Fall protection system

KAS8 / KAG8 + P						
-----------------	--	--	--	--	--	--

Rückhaltesystem / Système de retenue / Sistema di ritenuta / Restraint system

KAS8 / KAG8 + P						
-----------------	--	--	--	--	--	--

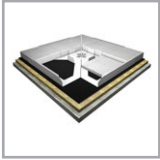

ALS

ALS	✓	✓	max. 300	✓	✓	✓
SP 16 H P			max. 300	✓	✓	✓
STR 42			max. 300	✓	✓	✓
Quattro				✓	✓	✓
EAP F				✓		
2DSF8						✓
3DSF8					✓	✓

Absturzicherungssystem / Système de protection antichute / Sistema di protezione anticaduta / Fall protection system

KAS8 / KAG8 + P			0			
KAS8 / KAG8 + P + STR / SP			100-300			

Rückhaltesystem / Système de retenue / Sistema di ritenuta / Restraint system

KAS8 / KAG8 + P			0			
KAS8 / KAG8 + P + STR / SP			100-300			